



Model no.:	Stock no.:
Serial no.:	
Purchased from:	
Date purchased:	Date in service:

Operating Instructions and Parts Manual S90 Series Hand Chain Hoists



For S90-100 serial no. 15070361H and higher
For S90-150 serial no. 15070389H and higher
For S90-300 serial no. 15070605H and higher
For S90-1000 serial no. 15070767H and higher

1-Ton model shown

JET
427 New Sanford Road
LaVergne, Tennessee 37086
Ph.: 800-274-6848
www.jettools.com

Part No. M-101900
Revision C1 07/2018
Copyright © 2018 JET



1.0 IMPORTANT SAFETY INSTRUCTIONS

WARNING – To reduce risk of injury:

1. Read and understand the entire owner's manual before attempting assembly or operation.
2. Read and understand the warnings posted on the tool and in this manual. Failure to comply with all of these warnings may cause serious injury and/or damage to property.
3. Replace the warning labels if they become obscured or are missing.
4. Keep visitors a safe distance from the work area. **Keep children away.**
5. Give your work undivided attention. Looking around, carrying on a conversation and "horse-play" are careless acts that can result in serious injury.
6. Provide for adequate space surrounding work area and non-glare, overhead lighting.
7. This chain hoist is designed and intended for use by properly trained and experienced personnel only. If you are not familiar with the proper and safe operation of a chain hoist, do not use until proper training and knowledge have been obtained.
8. Do not use this chain hoist for other than its intended use. If used for other purposes, JET disclaims any real or implied warranty and holds itself harmless from any injury that may result from that use.
9. Do not use to lift people or loads over people.
10. Do not exceed the rated capacity of the chain hoist.
11. Do not use more than hand power to pull the hand chain.
12. Do not use the load chain as a sling; this may cause damage to the chain.
13. Always inspect the chain hoist for damage prior to use. If the chain hoist is damaged, do not use until it has been repaired or replaced.
14. Do not use more than one chain hoist to lift or move a load. If this is unavoidable, each chain hoist must have the same capacity as the load to be moved.
15. Never allow the load chain to "set" over sharp edges. All lifts must be made with straight chain that is free of obstacles.
16. If the hand chain is difficult to operate, then the load exceeds the capacity of the chain hoist. Select a chain hoist of larger capacity.
17. Do not use a chain hoist unless load is centered between top and bottom hooks.
18. Always take time to study the job to be performed and choose the safest method. Do not place yourself or other people in an unsafe position.
19. Stand to one side of the load being lifted and make sure no one else is standing underneath when lifting a load. Should a load slip, it will descend at a high rate of speed and can cause serious injuries to anyone standing directly underneath.
20. Leave all internal maintenance to a qualified JET Service Center.
21. Replace the chain with factory replacement chain only. Do not use any other type of chain.
22. If welding near the hoist, do not allow the chain or hook to be touched by a live electrode. Prevent weld splatter upon the chain.
23. Never use the chain hoist if either hook is stretched, deformed, or has a broken or missing safety latch. Always replace the safety latch and/or the hook before placing the chain hoist back into service.
24. Understand and follow all procedures as set forth in American National Standards titled "Performance Standard for Hand Chain Manually Operated Chain Hoists." ANSI/ASME HST-2; and "Overhead Hoists (Underhung)," ANSI/ASME B30.16. These standards are available through the American Society of Mechanical Engineers, www.ASME.org

 **WARNING:** This product can expose you to chemicals including lead, which is known to the State of California to cause cancer and birth defects or other reproductive harm. For more information go to <http://www.p65warnings.ca.gov>.

Familiarize yourself with the following safety notices used in this manual:



This means that if precautions are not heeded, it may result in minor injury and/or possible machine damage.



This means that if precautions are not heeded, it may result in serious injury or possibly even death.

2.0 Table of Contents

Section	Page
1.0 IMPORTANT SAFETY INSTRUCTIONS	2
2.0 Table of Contents.....	3
3.0 About this manual	4
4.0 Specifications and Dimensions for S90 Series Chain Hoists	5
5.0 Using the Chain Hoist	6
5.1 Prior to Operation	6
5.2 Hooking the load	6
5.3 Raising the Load	7
6.0 Hand chain: Cutting and installing.....	7
7.0 Load chain: Removing and installing	8
7.1 Load chain inspection.....	8
7.2 Load chain removal (all models)	8
7.3 Attaching load chain to load chain sprocket (all models)	8
7.4 Completing load chain installation	9
7.5 Chain installation: 0.5T thru 2T	9
7.6 Chain installation: 3T and 5T.....	9
7.7 Chain installation: 10T.....	10
8.0 Inspection and maintenance	11
9.0 Load and wear limits	12
9.1 Alloy steel chain	12
9.2 Hooks (top and bottom)	12
9.3 Brake disc.....	13
10.0 Timing Marks for Gear Replacement	13
11.0 Troubleshooting JET® Manual Chain Hoists	14
12.0 Replacement Parts.....	15
12.1.1 S90 Chain Hoists – Exploded View.....	15
12.1.2 S90-050 Chain Hoist (0.5 Ton) – Parts List.....	16
12.1.3 S90-100 Chain Hoist (1 Ton) – Parts List.....	18
12.1.4 S90-150 Chain Hoist (1.5 Ton) – Parts List.....	20
12.1.5 S90-200 Chain Hoist (2 Ton) – Parts List.....	22
12.1.6 S90-300 Chain Hoist (3 Ton) – Parts List.....	24
12.1.7 S90-500 Chain Hoist (5 Ton) – Parts List.....	26
12.1.8 S90-1000 Chain Hoist (10 Ton) – Parts List.....	28
13.0 Warranty and Service.....	30

3.0 About this manual

This manual is provided by JET covering the safe operation and maintenance procedures for a JET Series S90 Manual Chain Hoist. This manual contains instructions on installation, safety precautions, general operating procedures, maintenance instructions and parts breakdown. Your hoist has been designed and constructed to provide consistent, long-term operation if used in accordance with the instructions as set forth in this document.

If there are questions or comments, please contact your local supplier or JET. JET can also be reached at our web site: www.jettools.com.

Retain this manual for future reference. If the hoist transfers ownership, the manual should accompany it.

 **WARNING Read and understand the entire contents of this manual before attempting assembly or operation! Failure to comply may cause serious injury!**

Register your product using the mail-in card provided, or register online:
<http://www.jettools.com/us/en/service-and-support/product-registration/>

The JET S90 hoists comply with OSHA, ANSI/ASME B30.16 and HST-2 standards.

The specifications in this manual were current at time of publication, but because of our policy of continuous improvement, JET, reserves the right to change specifications at any time and without prior notice, without incurring obligations.

4.0 Specifications and Dimensions for S90 Series Chain Hoists

Table 1

Capacity (tonnes)	Model No.	No. of Falls	Load Chain Grade (mm)	Load Chain Grade	Pull to Lift Rated Load (lbs)	Test Load (tonnes)	Hand Chain (mm)	Std. Lift m (ft)	Net Wt. kg (lb)	Gross Wt. kg (lb)	Required Hand Chain (ft.) to Lift Capacity 1ft	0.5 t, 1 t, 1.5 t & 2 t			3 t & 5 t			10 t		
												a	b	c	d	e	f	g	h	
0.5 t	S90-050	1	5 X 15	80	58.5	0.75	5 X 25	3 (10)	7.8 (17.2)	8.1 (17.9)	32	125 (5)	130 (5.1)	43 (1.7)	25 (1)	27 (1.1)	32 (1.3)	35 (1.4)	280 (11)	
1 t	S90-100	1	6 X 18	80	60.5	1.5	5 X 25	3 (10)	11.1 (24.5)	11.5 (25.4)	53	134 (5.3)	155 (6.1)	51 (2)	30 (1.2)	33 (1.3)	40 (1.6)	45 (1.8)	308 (12)	
1.5 t	S90-150	1	8 X 24	80	84.4	2.25	5 X 25	3 (10)	15.8 (34.8)	16.2 (35.7)	57	151 (6)	173 (6.8)	64 (2.5)	34 (1.3)	33.5 (1.3)	42 (1.7)	47 (1.9)	368 (14.5)	
2 t	S90-200	1	8 X 24	80	91.6	3.0	5 X 25	3 (10)	16.8 (37)	17.3 (38.4)	71	157 (6.2)	185 (7.3)	64 (2.5)	34 (1.3)	37 (1.5)	46 (1.8)	52 (2)	445 (17.5)	
3 t	S90-300	2	8 X 24	80	86.8	4.5	5 X 25	3 (10)	24.2 (53.4)	24.7 (54.5)	115	157 (6.2)	235 (9.3)	100 (4)	56 (2.2)	43.5 (1.7)	52 (2)	62.5 (2.5)	520 (20.5)	
5 t	S90-500	2	10 X 30	80	90.4	7.5	5 X 25	3 (10)	39.8 (87.7)	40.2 (88.5)	178	180 (7.1)	262 (10.3)	126 (5)	74 (3)	51 (2)	60 (2.4)	79 (3)	600 (23.6)	
10 t	S90-1000	4	10 X 30	80	95.8	12.5	5 X 25	3 (10)	70.7 (155.9)	81.5 (179.7)	357	180 (7.1)	365 (14.4)	260 (10.2)	98 (3.9)	84 (2.5)	85 (3.3)	760 (30)		

¹ Chain is available in various lengths. Specify required length when ordering.

² Gross weight includes shipping/packaging materials.

5.0 Using the Chain Hoist

5.1 Prior to Operation

1. Support for the hoist may be hook, clevis pin, trolley, or beam clamp. Whatever method of suspension is chosen, the support components **must** be rated equal to, or greater than the capacity of the chain hoist.
2. If the chain hoist has not been used for an extended period of time, check for proper operation before putting into service.
3. The brake mechanism must be kept clean and free from dirt, water, and oil. Never allow oil to penetrate the brake mechanism. Always keep your chain hoist clean and store in a clean, dry location.
4. Although oiling the chain is not mandatory, a light coat of 30W oil applied periodically to the chain will create easier operation and prolong the life of the chain.
5. Check the chain for damage and elongation. Replace damaged chain before using the chain hoist.

The load chain supplied with your JET chain hoist is designed, manufactured, and tested for proper fit and durability. Over a period of time, the chain may need to be replaced. For your own safety, use factory replacement chain only.

WARNING Use of other than factory replacement chain may cause serious injury and/or damage to the hoist.

6. The top and bottom hooks on your JET chain hoist are designed to open to warn of an overload. Both top and bottom hooks (1/2T to 5T models) have indicator points cast into the hook. See Figure 1. The measurement between indicator points must fall below the limit shown in section 9.2, Table 3. If it exceeds the limit, the hook must be replaced.



Figure 1

7. It is important to check top and bottom hooks for proper opening. If the safety latch no longer contacts the hook opening, replace the hook. **Never side load the top or bottom hook; this practice is dangerous and could lead to serious injury.**
8. If the vertical angle at the neck of the bottom or top hook reaches 10°, replace the hook (see Figure 2).

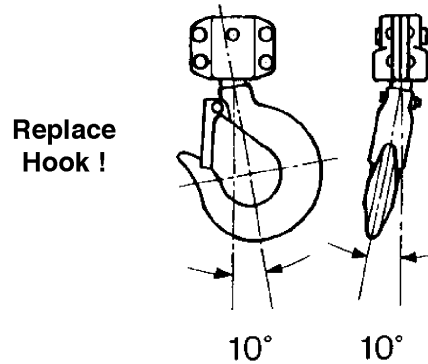

Figure 2

5.2 Hooking the load

1. Secure the upper hook.
2. Place the bottom hook securely into the object to be lifted.
3. Place ropes or chain in the center of the bottom hook, making sure the safety latch is secure. Never load the hook in front of the safety latch. See Figure 3.

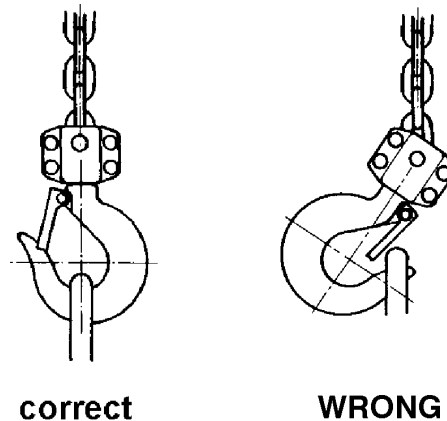

Figure 3

4. Avoid lifting one load with two hoists. If this is unavoidable, apply equal weight to both hoists and use hoists with the proper lift capacity. **Capacity of each hoist must be equal to the total load to be lifted.**

5. Check that the chain is not twisted at the bottom hook. All welds should face the same direction (Figure 4).

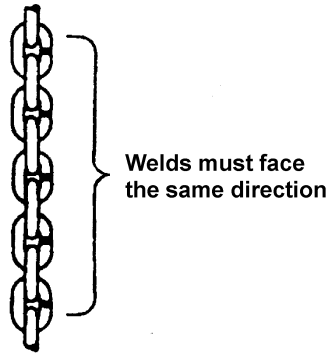

Figure 4

6. For hoists with two or more falls of chain, make sure the bottom hook is not capsized (turned over). This may cause the chain to twist.

5.3 Raising the Load

To raise load, pull right side of hand chain (A, Figure 5) so that wheel turns clockwise.

To lower load, pull left side of hand chain (B, Figure 5) so that wheel turns counterclockwise.

Important: Make sure hoist has an adequate length of load chain to raise or lower the load in a safe manner. Do not attempt to lower hoist beyond its limit.

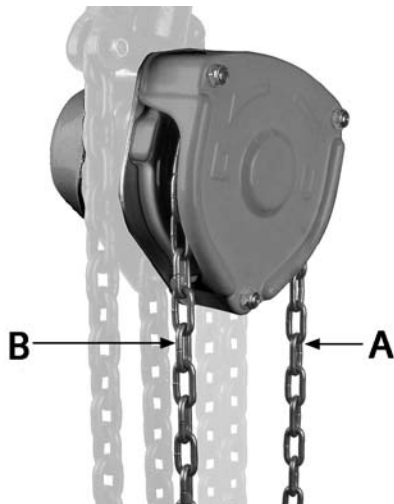

Figure 5

6.0 Hand chain: Cutting and installing

To cut hand chain in order to lengthen or shorten:

1. Insert one link lengthwise into a vise (Figure 6). Be sure that the side opposite the weld lies completely below surface of vise jaw (about 1/3 of a link). This prevents nicking or cutting the lower part of the link.

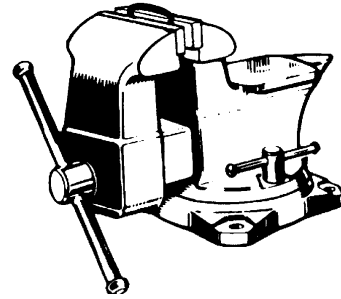

Figure 6

2. Using a hack saw, cut through upper part of link at the weld.
3. Loosen the link, reposition link vertically at edge of vise with the level of the cut above the vise jaw (Figure 7).

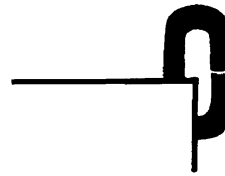

Figure 7

4. Tighten vise jaw.
5. Using an adjustable wrench, twist the link horizontally from front to back. (Figure 8) Open just far enough to insert (or remove) a second chain link.

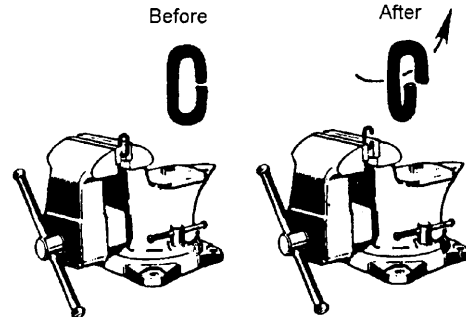

Figure 8

Note: Chain length is now ready to lengthen or shorten.

6. Insert (or remove) the second end link at the opening in the first end link.
7. Using an adjustable wrench, twist the link horizontally until the link is in the original closed position. See Figure 9.

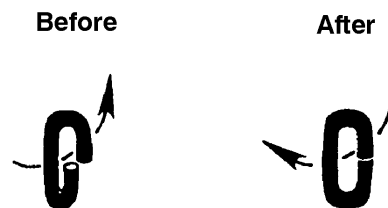

Figure 9

CAUTION Do not push the link inward from the curved ends. This will distort the link. Check that the link is closed and free of twist.

8. If installing entire new chain, insert end of hand chain into groove at top of hand chain wheel (see Figure 11). Rotate handwheel and pull chain through.
9. Re-weld the link at the cut.
10. Grind off excess on weld so that it is smooth.

WARNING Do not operate the hoist with a twisted, kinked or damaged load chain. Do not splice the load chain. Check the chain for excessive wear or stretch. Failure to comply may cause serious injury.

7.0 Load chain: Removing and installing

7.1 Load chain inspection

Over time, the load chain will wear or elongate. This can cause damage to the hoist, breakage, or non-engagement of the load sheave.

WARNING Do not operate the hoist with a twisted, kinked or damaged load chain. Do not splice load chain. Check the chain for excessive wear or stretch. Failure to comply may cause serious injury.

To inspect the load chain for wear:

1. Test the hoist under load in both the lifting and lowering directions, observing the operation of chain and sprockets. Chain should feed smoothly into and away from the sprockets.
2. If the chain binds, jumps, or is noisy, make sure it is clean and properly lubricated. If the trouble persists, inspect the chain and mating parts for wear, distortion, or other damage.
3. Clean the chain before inspection. Examine for gouges, nicks, weld splatter, corrosion, and distorted links. Slacken the chain and move adjacent links to one side, looking for wear at the contact points. If you see wear or suspect stretching, measure the chain as explained in section 10.1. If chain matches or exceeds the limit shown in Table 2, replace the load chain before using the hoist.

WARNING Do not add to the load chain. Replace entire chain. Failure to comply may cause serious injury.

7.2 Load chain removal (all models)

Remove old load chain as follows while referring to Figure 10:

1. Remove *split pin* (A) and *pin stopper* (B) on the *chain anchor* (C), allowing the end of the load chain to fall free.
2. Pull the *hand chain* (Figure 5) until load chain is completely removed from gear assembly.

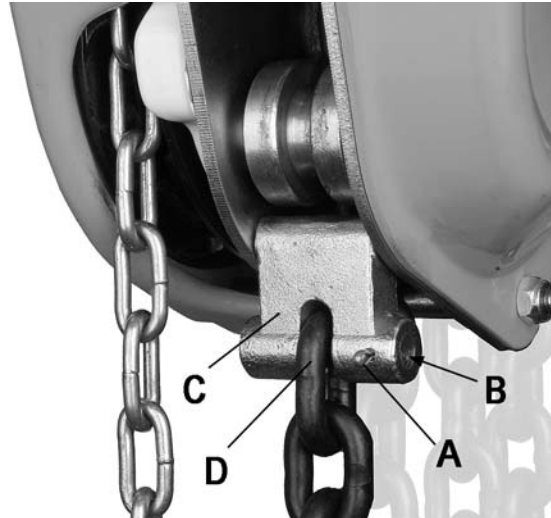

Figure 10

7.3 Attaching load chain to load chain sprocket (all models)

Install new load chain onto load chain sprocket as follows, referring to Figure 11:

1. Position the *load chain sprocket* (E) by rotating *hand chain wheel* (F) so that the wide and narrow grooves show.
2. Insert the load chain into the sprocket grooves so that chain will wind up and back over the sprocket. *Welds must face away from the sprocket.*
3. Rotate hand chain wheel so that load chain falls six to eight inches at back of sprocket.

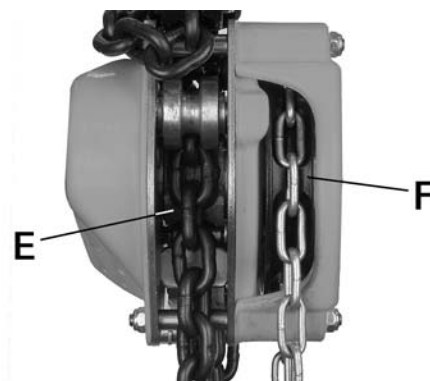

Figure 11

Referring back to Figure 10:

4. Insert one end of *chain link* (D) into *chain anchor* (C).
5. Insert *pin stopper* (B) through *chain anchor* (C) and *chain link* (D) and secure with *split pin* (A).

Continue with section 8.4, proceeding to the section that applies to your hoist.

7.4 Completing load chain installation

The following procedure assumes that the *load chain* has been attached to the *chain anchor* and fed through the *load chain sprocket* as described in the previous section. This procedure will complete the load chain and bottom hook installation.

7.5 Chain installation: 0.5T thru 2T

Referring to Figure 12:

1. Remove *lock nut and bolt* (D) from lower hook.
2. Insert the last *chain link* (C) into lower hook slot.
3. Re-insert bolt through lower hook slot and chain link.
4. Install lock nut onto bolt and tighten.

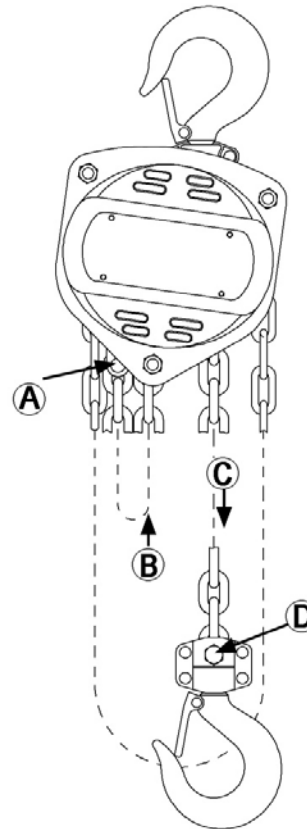

Figure 12

(1/2 through 2-ton hoists)

7.6 Chain installation: 3T and 5T

Referring to Figure 13:

1. After installing the load chain into *load chain sprocket* (B), run the remaining chain through your hand to remove any twist. The last link of the chain must be in the same direction as the first. If not, cut off the last link.
2. Insert the last link into pulley of *lower hook* (C).
3. Pull *load chain* through and up from underside of pulley (C,D).
4. Remove *lock nut and chain anchor pin* in *upper hook slot* (E).
5. Insert the last link into upper hook slot.
6. Check that load chain is not twisted.
7. Reinstall chain anchor pin through upper hook slot and last chain link, and secure with the lock nut.

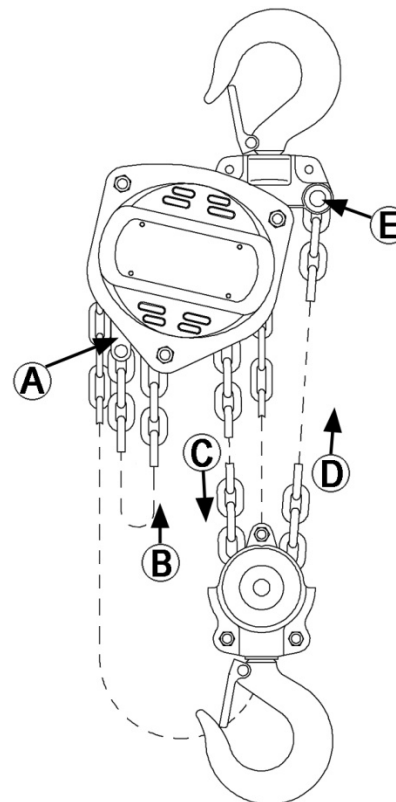

Figure 13

(3-ton and 5-ton hoists)

7.7 Chain installation: 10T

Referring to Figure 14:

1. After installing load chain into *load chain sprocket* (B), run the remaining chain through your hand to remove any twist. The last link of the chain must be in the same direction as the first. If not, cut off the last link.
2. Insert the last link into the left pulley of the *lower hook* (C).
3. Pull the *load chain* through and up from underside of the pulley (C, D).
4. Insert the *last link* into the pulley of the upper hook (D), moving the chain up, around, and then down (E). Check that the load chain is not twisted and welds face away from the pulley.
5. To prevent the chain from free-wheeling, insert a screwdriver securely into a link at the base of the upper pulley (left side).
6. Insert the *last link* into the right pulley of the lower hook (E).
7. Pull the *load chain* through and up from the underside of the pulley (E, F).
8. Remove the *lock nut* and *chain anchor pin* in upper hook slot (G).
9. Insert the last link into the upper hook slot.
10. Check that load chain is not twisted.
11. Reinstall chain anchor pin through upper hook slot and last chain link, and secure with lock nut.
12. Remove screwdriver from link at base of upper pulley.

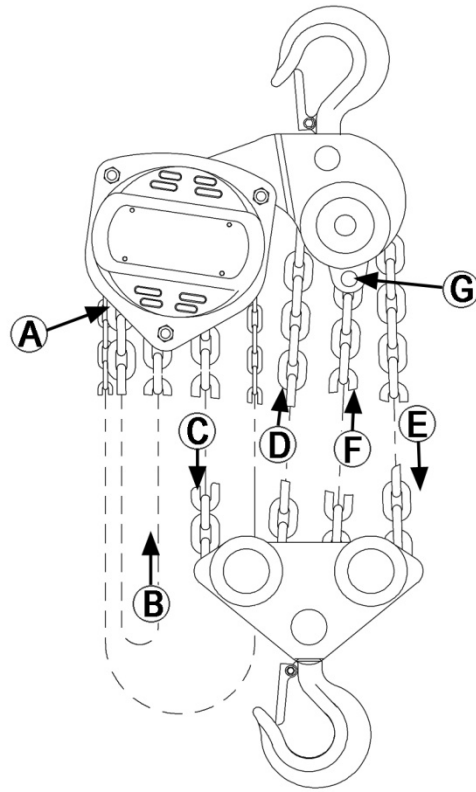

Figure 14
(10-ton hoists)

8.0 Inspection and maintenance

Read and follow ANSI Inspection and Maintenance Instructions. Know the meaning of Frequent Inspection, Periodic Inspection, Normal Service, Heavy Service, and Severe Service. It is the customer's responsibility to understand and follow all ANSI and JET inspection and maintenance instructions.

⚠WARNING All repairs and adjustments are to be performed by trained and experienced personnel using procedures that are approved for the hoist system being serviced.

⚠WARNING All safety related deficiencies discovered in the inspection are to be corrected before the hoist is placed back into service.

⚠WARNING Check for internal damage whenever external damage has occurred. Failure to comply may cause serious injury.

1. Clean hoist after each use and oil lightly.
2. Do not drop or drag the hoist.
3. Store the hoist in a clean and dry environment.
4. Chain oiling is not mandatory but will increase the life of the chain.
5. Leave all repairs and adjustments of internal parts to qualified repair personnel.
6. Inspect the load chain and the lower hook after lifting a maximum weight load.
7. This hoist uses special alloy hoisting chain and does not interchange with any other manufacturer. All replacement chain must be purchased from your JET distributor or from JET directly by calling 800-274-6848.
8. Check and inspect the brake system frequently.
9. Annually, the hoist should be disassembled, inspected, and cleaned by trained and experienced personnel only. Contact a JET authorized service center by calling your dealer or visiting our web site at jettools.com.
10. After servicing, test the hoist with no load, then test the hoist with a load.

9.0 Load and wear limits

9.1 Alloy steel chain

Carefully inspect entire load chain. As illustrated in Figure 15, measure five consecutive links with calipers to measure the length. Check every three feet and especially where excessive wear is indicated. Any load chain that shows noticeable deformation or heat influence must be replaced with a new one. Never extend load chain by welding a second piece to the original.

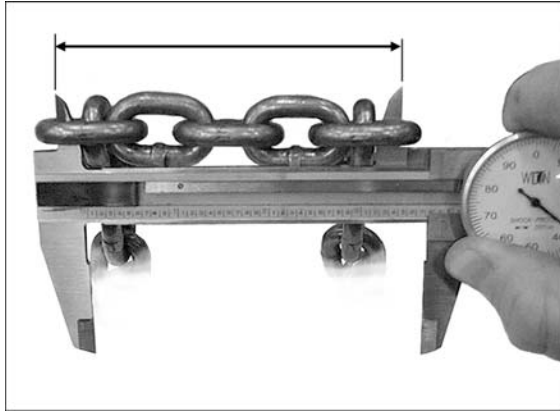

Figure 15

Capacity	5 Links Normal (mm)	5 Links Limit Replace if:
0.5 ton	75	77.3
1 ton	90	92.6
1.5 ton	120	123.4
2 ton	120	123.4
3 ton	120	123.4
5 ton	150	154.3
10 ton	150	154.3

Table 2

9.2 Hooks (top and bottom)

See Figure 16.

Replace hook when “A” measurement is equal to or greater than the “A” Limit in the table below. Never heat treat the hook or attach anything to the hook by welding.

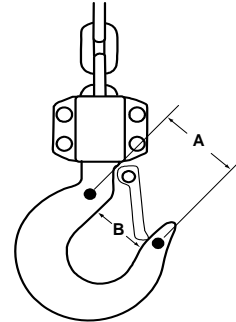

Figure 16

Capacity	Load chain column	“A” Norm	“A” Limit	“B” Norm	“B” Limit
0.5 ton	1	1.36"	1.44"	–	–
1 ton	1	1.77"	1.88"	–	–
1.5 ton	1	1.86"	1.97"	–	–
2 ton	1	2.05"	2.17"	–	–
3 ton	2	2.45"	2.60"	–	–
5 ton	2	3.06"	3.24"	–	–
10 ton	4	–	–	2.52"	2.67"

Table 3

9.3 Brake disc

Replacement limits for brake disc.

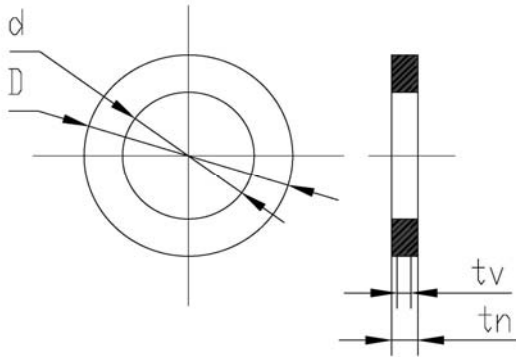

Figure 17

Capacity	Load chain column	D (mm)	d (mm)	tn (mm)	tv (mm)
0.5 ton	1	39	22	2.5	2
1 ton	1	60	30.5	2	1.5
1.5 ton	1	68	35.5	2	1.5
2 ton	1	68	35.5	2	1.5
3 ton	2	68	35.5	2	1.5
5 ton	2	85	45.5	2.5	2
10 ton	4	85	45.5	2.5	2

Table 4

d = inner diameter
 D = outer diameter
 tn = normal measurement
 tv = replacement limit

10.0 Timing Marks for Gear Replacement

If the gears on the S90 hoist need replacement or removal for any reason, make sure they are re-installed correctly. Figure 18 shows the proper orientation of the timing marks when meshing the gears.

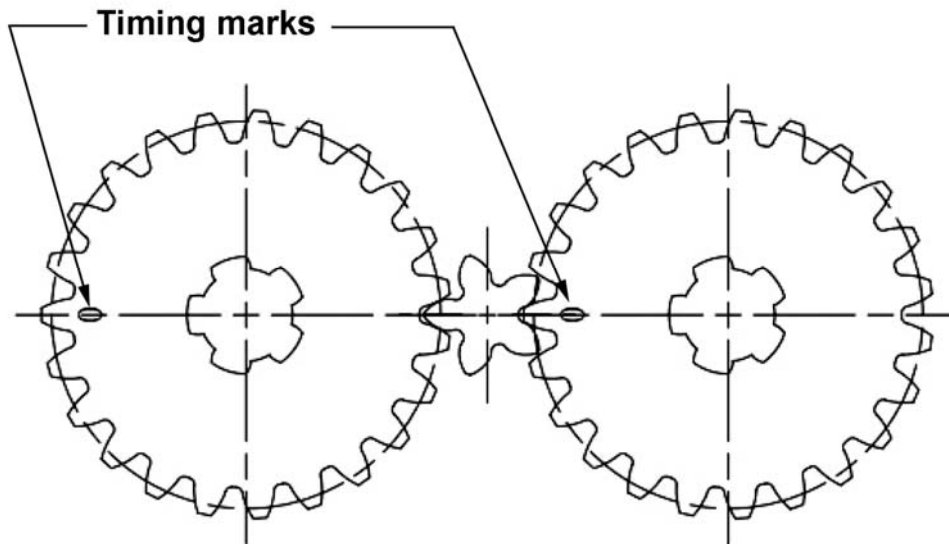

Figure 18

11.0 Troubleshooting JET® Manual Chain Hoists

Symptom	Possible Cause	Correction ¹
Hoist will not move in either direction.	Hand chain wheel is jammed, worn, or damaged.	Inspect and clean hand chain and hand chain wheel. Replace if worn or damaged.
	Hand chain slips over wheel.	Check hand chain wheel for damage or worn cogs. Replace if needed.
	Load sheave or load chain is jammed.	Inspect and clean. Check for chain link deformation. Replace elements if needed. Oil load chain for optimal performance.
	Load gear/spur gears jammed due to obstruction or damage.	Inspect, clean, and re-grease gears. Replace if worn or damaged.
	Bearing failure.	Contact JET service center for disassembly and replacement of bearings.
Hoist will not lift load, or lifts with great difficulty.	Load too heavy for hoist.	Use a hoist with proper capacity for load.
	<i>(models with overload protection²):</i> Slip clutch overload protection has been triggered due to excess load capacity.	Disengage overload to reset hoist (see instruction manual). Only lift loads within hoist capacity. Inspect hoist elements for damage after overload has occurred.
	Load chain is binding.	Inspect and clean load chain, load sheave, and stripper. Make sure chain is not twisted. Oil chain for optimal performance. Replace elements if deformation or other damage is found.
	Load sheave is jammed.	Inspect and clean. Replace load sheave if damaged or excessively worn.
	Ratchet disc teeth, pawls or pawl springs worn or damaged.	Inspect elements and replace if needed.
	Bearing failure.	Contact JET service center for disassembly and replacement of bearings.
Hoist will not lower load, or lowers with great difficulty.	Load chain is binding due to obstruction, damage or wear.	Inspect and clean load chain and load sheave. Keep load chain lightly oiled. Replace chain if damaged or worn.
	Brake/ratchet disc not releasing due to obstruction or damage.	Inspect and clean ratchet and pawl assemblies.
Load drifts downward while suspended.	Load beyond capacity of hoist.	Use properly rated hoist for load.
	Ratchet disc teeth, pawls or pawl springs worn or damaged.	Inspect elements and replace if needed.
	Brake disc(s) worn or dirty.	Inspect brake disc(s) for wear or damage. Consult thickness tolerances in manual, replace if needed.
Load chain jumps, or makes excessive noise.	Load chain is dirty or dry.	Inspect and clean load chain and load sheave. Oil chain for optimum performance.
	Load chain kinked or twisted.	Remove twists in chain.
	Load chain is worn or deformed, or otherwise damaged.	Replace chain (use JET-authorized chain only).
	Chain catching in load sheave.	Inspect and clean chain and sheave. Check for chain deformations.
Hook latch not closing.	Latch is bent or broken.	Replace latch.
	Hook is deformed preventing proper latch operation.	Replace hook assembly.

¹ Some corrections may need to be performed by a JET authorized service center.

² Identified by "WO" in model number.

12.0 Replacement Parts

Replacement parts are listed on the following pages. To order parts or reach our service department, call 1-800-274-6848 Monday through Friday, 8:00 a.m. to 5:00 p.m. CST. Having the Model Number and Serial Number of your machine available when you call will allow us to serve you quickly and accurately.

Non-proprietary parts, such as fasteners, can be found at local hardware stores, or may be ordered from JET. Some parts are shown for reference only, and may not be available individually.

12.1.1 S90 Chain Hoists – Exploded View

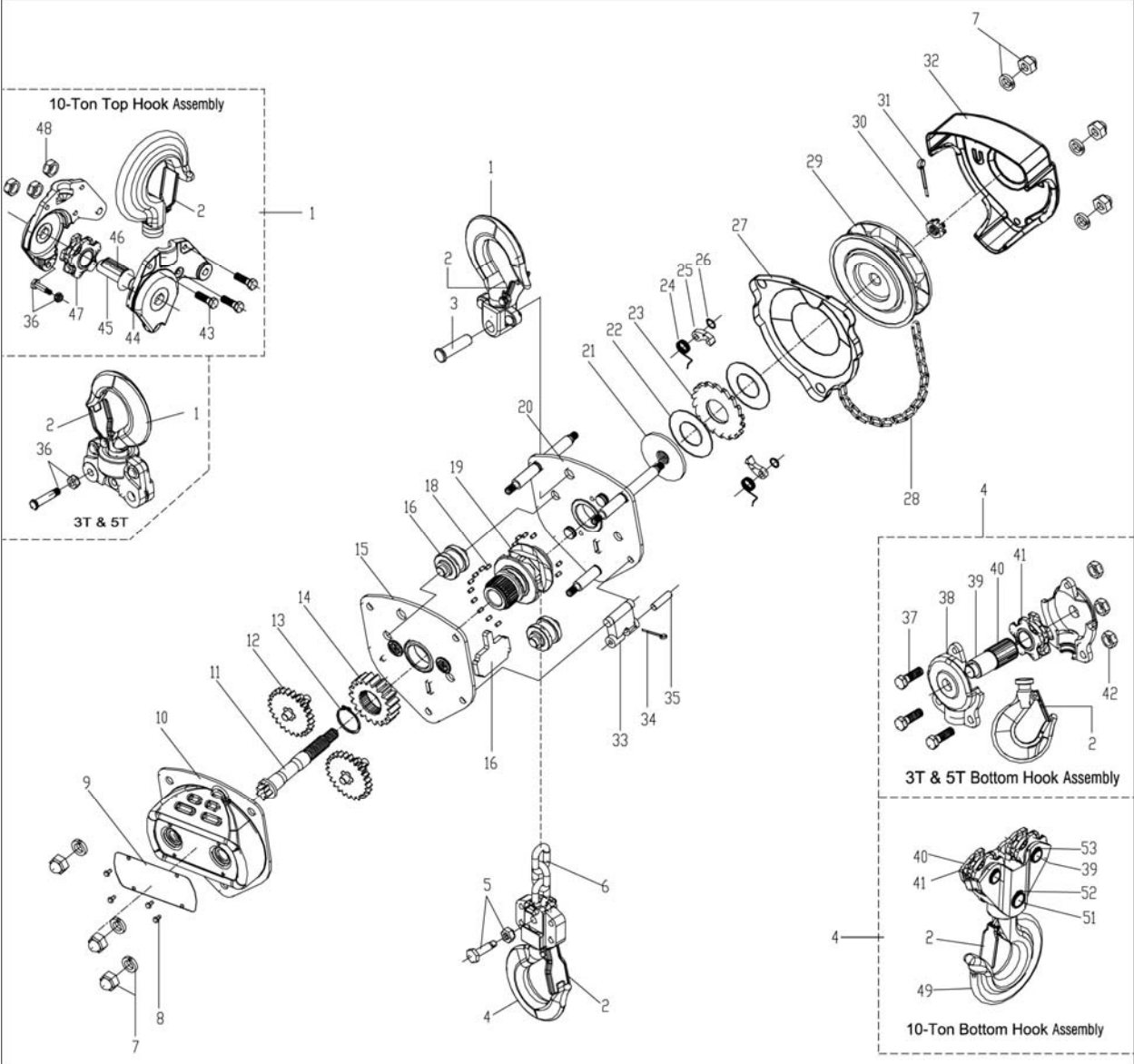

12.1.2 S90-050 Chain Hoist (0.5 Ton) – Parts List

Index No	Part No	Description	Size	Qty
1	S90-050-1G	Top Hook Assembly		1
		Top Hook		1
		Safety Latch		1
		Double Spring		1
		Socket Head Cap Screw	M4x20	1
		Lock Nut	M4	1
		Top Hook Holder		1
		Rivet	5x20mm	2
2	S90-050-2	Safety Latch Assembly		2
		Safety Latch		2
		Double Spring		2
		Socket Head Cap Screw	M4x20	2
		Lock Nut	M4	2
3	S90-050-3	Top Hook Shaft		1
4	S90-050-4G	Bottom Hook Assembly		1
		Bottom Hook		1
		Safety Latch		1
		Double Spring		1
		Socket Head Cap Screw	M4x20	1
		Lock Nut	M4	1
		Bottom Hook Holder		1
		Rivet	5x20mm	2
5	L100-50-6	Bottom Hook Shaft and Lock Nut	M6	1
6	187721	Load Chain – <i>specify length</i>	5x15mm	1
7	L100-25-27G	Acorn Nut with Lock Washer	M6	6
8	L100-50-28	Rivet	3x5mm	4
9	LM000033	Name Plate		1
10	S90-050-10G	Gear Cover Assembly		1
		Gear Cover		1
		Bushing		2
11	S90-050-11	Drive Shaft		1
12	S90-050-12	Spur Gear Assembly		2
		Spur Gear		2
		Pinion Gear		2
13	L100-50-47	Snap Ring	18mm	1
14	S90-050-14	Load Gear		1
15	S90-050-15	Gear Side Plate Assembly		1
		Gear Side Plate		1
		Bearing Race		1
		Bushing		2
16	S90-050-16	Stripper		1
17	L100-50-32	Guide Roller		2
18	S90-050-18	Roller Set (Right and Left)	ø3x5mm	56
19	S90-050-19	Load Sheave		1
20	S90-050-20	Wheel Side Plate Assembly		1
		Stay Bolt		3
		Pawl Pin		2
		Bearing Race		1
21	S90-050-21	Disc Hub		1
22	S90-050-22	Brake Disc		2
23	S90-050-23	Ratchet Disc		1
24	S90-050-24	Pawl Spring		2
25	S90-050-25	Pawl		2
26	S90-050-26	Snap Ring	6mm	2
27	S90-050-27G	Brake Cover		1
28	S90-050-28	Hand Chain – <i>specify length</i>	5x25mm	1
29	S90-050-29	Hand Chain Wheel		1
30	S90-050-30	Pinion Nut	M8	1
31	L100-50-4	Split Pin	2x20mm	1

Index No	Part No	Description	Size	Qty
32	S90-050-32G	Hand Wheel Cover		1
33	L100-50-34	Chain Anchor Plate		1
34	S90-050-34	Split Pin	1.6x15mm	1
35	L100-50-35	Chain Anchor Pin		1
	L100-WT	Warning Tag (not shown)		1

Note: When ordering replacement chains (index #6 and 28), specify length.

12.1.3 S90-100 Chain Hoist (1 Ton) – Parts List

Index No	Part No	Description	Size	Qty
1	S90-100-1G	Top Hook Assembly		1
		Top Hook		1
		Safety Latch		1
		Double Spring		1
		Socket Head Cap Screw	M4x20	1
		Lock Nut	M4	1
		Top Hook Holder		1
		Rivet	6x20mm	2
2	S90-100-2	Safety Latch Assembly		2
		Safety Latch		2
		Double Spring		2
		Socket Head Cap Screw	M4x20	2
		Lock Nut	M4	2
3	S90-100-3	Top Hook Shaft		1
4	S90-100-4G	Bottom Hook Assembly		1
		Bottom Hook		1
		Safety Latch		1
		Double Spring		1
		Socket Head Cap Screw	M4x20	1
		Lock Nut	M4	1
		Bottom Hook Holder		1
		Rivet	5x20mm	2
5	S90-100-5	Bottom Hook Shaft and Lock Nut	M6	1
6	JLP75A-44	Load Chain – <i>specify length</i>	6x18mm	1
7	L100-50-27G	Acorn Nut with Lock Washer	M8	6
8	L100-100-28	Rivet	3x5mm	4
9	LM000034	Name Plate		1
10	S90-100-10G	Gear Cover Assembly		1
		Gear Cover		1
		Bushing		2
11	S90-100-11	Drive Shaft		1
12	S90-100-12	Spur Gear Assembly		2
		Spur Gear		2
		Pinion Gear		2
13	L100-50-47	Snap Ring	22mm	1
14	S90-100-14	Load Gear		1
15	S90-100-15	Gear Side Plate Assembly		1
		Gear Side Plate		1
		Bearing Race		1
		Bushing		2
16	JLP75A-31	Stripper		1
17	S90-100-17	Guide Roller		2
18	JLP75A-29	Roller Set (Right and Left)	ø3x6mm	74
19	S90-100-19	Load Sheave		1
20	S90-100-20	Wheel Side Plate Assembly		1
		Stay Bolt		3
		Pawl Pin		2
		Bearing Race		1
21	S90-100-21	Disc Hub		1
22	S90-100-22	Brake Disc		2
23	S90-100-23	Ratchet Disc		1
24	S90-100-24	Pawl Spring		2
25	S90-100-25	Pawl		2
26	S90-100-26	Snap Ring	7mm	2
27	S90-100-27G	Brake Cover		1
28	S90-050-28	Hand Chain – <i>specify length</i>	5x25mm	1
29	S90-100-29	Hand Chain Wheel		1
30	S90-100-30	Pinion Nut	M10	1
31	JLP150A-03	Split Pin	2.5x25mm	1

Index No	Part No	Description	Size	Qty
32	S90-100-32G	Hand Wheel Cover		1
33	S90-100-33	Chain Anchor Plate		1
34	L100-50-4	Split Pin	2x20mm	1
35	S90-100-35	Chain Anchor Pin		1
	L100-WT	Warning Tag (not shown)		1

Note: When ordering replacement chains (index #6 and 28), specify length.

12.1.4 S90-150 Chain Hoist (1.5 Ton) – Parts List

Index No	Part No	Description	Size	Qty
1	S90-150-1G	Top Hook Assembly		1
		Top Hook		1
		Safety Latch		1
		Double Spring		1
		Socket Head Cap Screw	M4x25	1
		Lock Nut	M4	1
		Top Hook Holder		1
		Rivet	6x24mm	2
2	JLP150A-63	Safety Latch Assembly		2
		Safety Latch		2
		Double Spring		2
		Socket Head Cap Screw	M4x25	2
		Lock Nut	M4	2
3	S90-150-3	Top Hook Shaft		1
4	S90-150-4G	Bottom Hook Assembly		1
		Bottom Hook		1
		Safety Latch		1
		Double Spring		1
		Socket Head Cap Screw	M4x25	1
		Lock Nut	M4	1
		Bottom Hook Holder		1
		Rivet	6x20mm	2
5	S90-150-5	Bottom Hook Shaft and Lock Nut	M8	1
6	JLP150A-44	Load Chain – <i>specify length</i>	8x24mm	1
7	L100-50-27G	Acorn Nut with Lock Washer	M8	6
8	L100-100-28	Rivet	3x5mm	4
9	LM000035	Name Plate		1
10	S90-150-10G	Gear Cover Assembly		1
		Gear Cover		1
		Bushing		2
11	S90-150-11	Drive Shaft		2
12	S90-150-12A	Spur Gear Assembly		2
		Spur Gear		2
		Pinion Gear		2
13	L100-300-47	Snap Ring	28mm	1
14	S90-150-14	Load Gear		1
15	S90-150-15A	Gear Side Plate Assembly		1
		Gear Side Plate		1
		Bearing Race		1
		Bushing		2
16	JLP150A-31	Stripper		1
17	S90-150-17	Guide Roller		2
18	S90-150-18	Roller Set (Right and Left)	ø4x6mm	60
19	S90-150-19	Load Sheave		1
20	S90-150-20	Wheel Side Plate Assembly		1
		Stay Bolt		3
		Pawl Pin		2
		Bearing Race		1
21	S90-150-21	Disc Hub		1
22	S90-150-22	Brake Disc		2
23	S90-150-23	Ratchet Disc		1
24	S90-150-24	Pawl Spring		2
25	S90-150-25	Pawl		2
26	S90-150-26	Snap Ring	8mm	2
27	S90-150-27G	Brake Cover		1
28	S90-050-28	Hand Chain – <i>specify length</i>	5x25mm	1
29	S90-150-29	Hand Chain Wheel		1
30	S90-150-30	Pinion Nut	M12	1
31	S90-150-31	Split Pin	3x25mm	1

Index No	Part No	Description	Size	Qty
32	S90-150-32G	Hand Wheel Cover		1
33	S90-150-33	Chain Anchor Plate		1
34	S90-150-34	Split Pin	2.5x23mm	1
35	S90-150-35	Chain Anchor Pin		1
	L100-WT	Warning Tag (not shown)		1

Note: When ordering replacement chains (index #6 and 28), specify length.

12.1.5 S90-200 Chain Hoist (2 Ton) – Parts List

Index No	Part No	Description	Size	Qty
1	S90-200-1G	Top Hook Assembly		1
		Top Hook		1
		Safety Latch		1
		Double Spring		1
		Socket Head Cap Screw	M5x30	1
		Lock Nut	M5	1
		Top Hook Holder		1
		Rivet	6x20mm	2
2	S90-200-2	Safety Latch Assembly		2
		Safety Latch		2
		Double Spring		2
		Socket Head Cap Screw	M5x30	2
		Lock Nut	M5	2
3	S90-200-3	Top Hook Shaft		1
4	S90-200-4G	Bottom Hook Assembly		1
		Bottom Hook		1
		Safety Latch		1
		Double Spring		1
		Socket Head Cap Screw	M5x30	1
		Lock Nut	M5	1
		Bottom Hook Holder		1
		Rivet	6x20mm	2
5	S90-200-5	Bottom Hook Shaft and Lock Nut	M8	1
6	JLP150A-44	Load Chain – <i>specify length</i>	8x24mm	1
7	JLP150A-40G	Acorn Nut with Lock Washer	M8	6
8	L100-100-28	Rivet	3x5mm	4
9	LM000036	Name Plate S90-200		1
10	S90-200-10G	Gear Cover Assembly		1
		Gear Cover		1
		Bushing		2
11	S90-200-11	Drive Shaft		1
12	S90-200-12A	Spur Gear Assembly		2
		Spur Gear		2
		Pinion Gear		2
13	S90-150-13	Snap Ring	28mm	1
14	S90-200-14	Load Gear		1
15	S90-200-15A	Gear Side Plate Assembly		1
		Gear Side Plate		1
		Bearing Race		1
		Bushing		2
16	JLP150A-31	Stripper		1
17	S90-200-17	Guide Roller		2
18	S90-150-18	Roller Set (Right and Left)	ø4x6mm	60
19	S90-200-19	Load Sheave		1
20	S90-200-20	Wheel Side Plate Assembly		1
		Stay Bolt		3
		Pawl Pin		2
		Bearing Race		1
21	S90-150-21	Disc Hub		1
22	S90-150-22	Brake Disc		2
23	S90-150-23	Ratchet Disc		1
24	S90-150-24	Pawl Spring		2
25	S90-150-25	Pawl		2
26	S90-150-26	Snap Ring	8mm	2
27	S90-200-27G	Brake Cover		1
28	S90-050-28	Hand Chain – <i>specify length</i>	5x25mm	1
29	S90-200-29	Hand Chain Wheel		1
30	S90-150-30	Pinion Nut	M12	1
31	S90-150-31	Split Pin	3x25mm	1

Index No	Part No	Description	Size	Qty
32	S90-200-32G	Hand Wheel Cover		1
33	S90-150-33	Chain Anchor Plate		1
34	S90-150-34	Split Pin	2.5x23mm	1
35	S90-150-35	Chain Anchor Pin		1
	L100-WT	Warning Tag (not shown)		1

Note: When ordering replacement chains (index #6 and 28), specify length.

12.1.6 S90-300 Chain Hoist (3 Ton) – Parts List

Index No	Part No	Description	Size	Qty
1	S90-300-1G	Top Hook Assembly		1
		Top Hook		1
		Safety Latch		1
		Double Spring		1
		Socket Head Cap Screw	M5x30	1
		Lock Nut	M5	1
		Top Hook Holder		1
		Rivet	10x32mm	2
2	JLP300A-63	Safety Latch Assembly		2
		Safety Latch		2
		Double Spring		2
		Socket Head Cap Screw	M5x30	2
		Lock Nut	M5	2
3	S90-150-3	Top Hook Shaft		1
4	S90-300-4G	Bottom Hook Assembly		1
		Bottom Hook		1
		Safety Latch		1
		Double Spring		1
		Socket Head Cap Screw	M5x30	1
		Lock Nut	M5	1
		Bottom Hook Holder		1
		Socket Head Cap Screw	M8x25	1
		Lock Nut	M8	1
		Socket Head Cap Screw	M10x25	2
		Lock Nut	M10	2
		Bottom Idle Shaft		1
		Bottom Idle Sheave		1
		Roller Pin	3x30mm	24
6	JLP150A-44	Load Chain – specify length	8x24mm	1
7	JLP150A-40G	Acorn Nut with Lock Washer	M8	6
8	L100-100-28	Rivet	3x5mm	4
9	LM000037	Name Plate, S90-300		1
10	S90-150-10G	Gear Cover Assembly		1
		Gear Cover		1
		Bushing		2
11	S90-150-11	Drive Shaft		1
12	S90-150-12A	Spur Gear Assembly		2
		Spur Gear		2
		Pinion Gear		2
13	S90-150-13	Snap Ring	28mm	1
14	S90-150-14	Load Gear		1
15	S90-150-15A	Gear Side Plate Assembly		1
		Gear Side Plate		1
		Bearing Race		1
		Bushing		2
16	JLP150A-31	Stripper		1
17	S90-150-17	Guide Roller		2
18	S90-150-18	Roller Set (Right and Left)	ø4x6mm	60
19	S90-150-19	Load Sheave		1
20	S90-150-20	Wheel Side Plate Assembly		1
		Stay Bolt		3
		Pawl Pin		2
		Bearing Race		1
21	S90-150-21	Disc Hub		1
22	S90-150-22	Brake Disc		2
23	S90-150-23	Ratchet Disc		1
24	S90-150-24	Pawl Spring		2
25	S90-150-25	Pawl		2
26	S90-150-26	Snap Ring	8mm	2

Index No	Part No	Description	Size	Qty
27	S90-150-27G	Brake Cover		1
28	S90-050-28	Hand Chain – <i>specify length</i>	5x25mm	1
29	S90-150-29	Hand Chain Wheel	5x25mm	1
30	S90-150-30	Pinion Nut	M12	1
31	S90-150-31	Split Pin	3x25mm	1
32	S90-150-32G	Hand Wheel Cover		1
33	S90-150-33	Chain Anchor Plate		1
34	S90-150-34	Split Pin	2.5x23mm	1
35	S90-150-35	Chain Anchor Pin		1
36	S90-300-36	Top Hook Pin and Lock Nut	M8	1
37	F005404	Socket Head Cap Screw	M8x25	1
	F005428	Socket Head Cap Screw	M10x25	2
38	S90-300-38G	Bottom Hook Holder		1
39	S90-300-39	Bottom Idle Shaft		1
40	S90-300-40	Roller Pin	3x30mm	24
41	S90-300-41	Bottom Idle Sheave		1
42	F001754	Lock Nut	M8	1
	F001755	Lock Nut	M10	2
	L100-WT	Warning Tag (not shown)		1

Note: When ordering replacement chains (index #6 and 28), specify length.

12.1.7 S90-500 Chain Hoist (5 Ton) – Parts List

Index No	Part No	Description	Size	Qty
1	S90-500-1G	Top Hook Assembly		1
		Top Hook		1
		Safety Latch		1
		Double Spring		1
		Socket Head Cap Screw	M5x30	1
		Lock Nut	M5	1
		Top Hook Holder		1
		Rivet	10x32mm	2
2	S90-500-2	Safety Latch Assembly		2
		Safety Latch		2
		Double Spring		2
		Socket Head Cap Screw	M5x30	2
		Lock Nut	M5	2
3	S90-500-3	Top Hook Shaft		1
4	S90-500-4G	Bottom Hook Assembly		1
		Bottom Hook		1
		Safety Latch		1
		Double Spring		1
		Socket Head Cap Screw	M5x30	1
		Lock Nut	M5	1
		Bottom Hook Holder		1
		Socket Head Cap Screw	M8x25	1
		Lock Nut	M8	1
		Socket Head Cap Screw	M10x25	2
		Lock Nut	M10	2
		Bottom Idle Shaft		1
		Bottom Idle Sheave		1
		Needle Bearing	3x40mm	29
6	JLP300A-44	Load Chain – specify length	10x30mm	1
7	JLP300A-40G	Acorn Nut with Lock Washer	M10	6
8	L100-100-28	Rivet	3x5mm	4
9	LM000038	Name Plate S90-500		1
10	S90-500-10G	Gear Cover Assembly		1
		Gear Cover		1
		Bushing		2
11	S90-500-11	Drive Shaft		1
12	S90-500-12A	Spur Gear Assembly		2
		Spur Gear		2
		Pinion Gear		2
13	L100-500-47	Snap Ring	32mm	1
14	L100-500-23	Load Gear		1
15	S90-500-15A	Gear Side Plate Assembly		1
		Gear Side Plate		1
		Bearing Race		1
		Bushing		2
16	JLP300A-31	Stripper		1
17	S90-500-17	Guide Roller		2
18	JLP300A-29	Roller Set (Right and Left)	ø5x6mm	60
19	S90-500-19	Load Sheave		1
20	S90-500-20	Wheel Side Plate Assembly		1
		Stay Bolt		3
		Pawl Pin		2
		Bearing Race		1
21	S90-500-21	Disc Hub		1
22	S90-500-22	Brake Disc		2
23	S90-500-23	Ratchet Disc		1
24	S90-500-24	Pawl Spring		2
25	S90-500-25	Pawl		2
26	JLH160-13	Snap Ring	9mm	2

Index No	Part No	Description	Size	Qty
27	S90-500-27G	Brake Cover		1
28	S90-050-28	Hand Chain – <i>specify length</i>	5x25mm	1
29	S90-500-29	Hand Chain Wheel		1
30	S90-500-30	Pinion Nut	M14	1
31	S90-500-31	Split Pin	3x30mm	1
32	S90-500-32G	Hand Wheel Cover		1
33	S90-500-33	Chain Anchor Plate		1
34	S90-150-34	Split Pin	2.5x23mm	1
35	S90-500-35	Chain Anchor Pin		1
36	S90-500-36	Top Hook Pin and Lock Nut	M10	1
37	F005404	Socket Head Cap Screw	M8x30	1
	F005429	Socket Head Cap Screw	M10x30	2
38	S90-500-38G	Bottom Hook Holder		1
39	S90-500-39	Bottom Idle Shaft		1
40	S90-500-40	Roller Pin	3x40mm	29
41	S90-500-41	Bottom Idle Sheave		1
42	F001754	Lock Nut	M8	1
	F001755	Lock Nut	M10	2
	L100-WT	Warning Tag (not shown)		1

Note: When ordering replacement chains (index #6 and 28), specify length.

12.1.8 S90-1000 Chain Hoist (10 Ton) – Parts List

Index No	Part No	Description	Size	Qty
1	S90-1000-1G	Top Hook Assembly		1
		Top Hook		1
		Safety Latch		1
		Double Spring		1
		Socket Head Cap Screw	M5x30	1
		Lock Nut	M5	1
		Top Hook Holder		1
		Socket Head Cap Screw	M12x45	3
		Nut	M12	3
		Lock Washer	12mm	3
		Top Idle Shaft		1
		Top Idle Sheave		1
		Needle Bearing	4x40mm	25
2	S90-1000-2	Safety Latch Assembly		2
		Safety Latch		2
		Double Spring		2
		Socket Head Cap Screw	M5x30	2
		Lock Nut	M5	2
3	S90-500-3	Top Hook Shaft		1
4	S90-1000-4G	Bottom Hook Assembly		1
		Bottom Hook		1
		Safety Latch		1
		Double Spring		1
		Socket Head Cap Screw	M5x30	1
		Lock Nut	M5	1
		Bottom Hook Holder		1
		Hook Collar Bushing		1
		Roller Pin	10mm	13
		Socket Head Cap Screw	M10x40	3
		Nut	M10	3
		Lock Washer	10mm	3
		Bottom Idle Shaft		2
		Bottom Idle Sheave		2
		Needle Bearing	3x40mm	58
6	JLP300A-44	Load Chain – <i>specify length</i>	10x30mm	1
7	JLP300A-40G	Acorn Nut with Lock Washer	M10	6
8	L100-100-28	Rivet	3x5mm	4
9	LM000039	Name Plate S90-1000		1
10	S90-500-10G	Gear Cover Assembly		1
		Gear Cover		1
		Bushing		2
11	S90-500-11	Drive Shaft		1
12	S90-500-12A	Spur Gear Assembly		2
		Spur Gear		2
		Pinion Gear		2
13	L100-500-47	Snap Ring	32mm	1
14	L100-500-48	Load Gear		1
15	S90-500-15A	Gear Side Plate Assembly		1
		Gear Side Plate		1
		Bearing Race		1
		Bushing		2
16	JLP300A-31	Stripper		1
17	S90-500-17	Guide Roller		2
18	JLP300A-29	Roller Set (Right and Left)	ø5x6mm	60
19	S90-500-19	Load Sheave		1
20	S90-500-20	Wheel Side Plate Assembly		1
		Stay Bolt		3
		Pawl Pin		2
		Bearing Race		1

Index No	Part No	Description	Size	Qty
21	S90-500-21	Disc Hub		1
22	S90-500-22	Brake Disc		2
23	S90-500-23	Ratchet Disc		1
24	S90-500-24	Pawl Spring		2
25	S90-500-25	Pawl		2
26	JLH160-13	Snap Ring	9mm	2
27	S90-500-27G	Brake Cover		1
28	S90-050-28	Hand Chain – <i>specify length</i>	5x25mm	1
29	S90-500-29	Hand Chain Wheel		1
30	S90-500-30	Pinion Nut	M14	1
31	S90-500-31	Split Pin	3x30mm	1
32	S90-500-32G	Hand Wheel Cover		1
33	S90-500-33	Chain Anchor Plate		1
34	S90-150-34	Split Pin	2.5x23mm	1
35	S90-500-35	Chain Anchor Pin		1
36	S90-500-36	Top Hook Pin and Lock Nut	M10	1
37	F005404	Socket Head Cap Screw	M10x40	3
38	S90-1000-38G	Bottom Hook Holder		1
39	S90-500-39	Bottom Idle Shaft		1
40	S90-500-40	Roller Pin	3x40mm	58
41	S90-500-41	Bottom Idle Sheave		2
42	S90-1000-42G	Nut and Lock Washer	M10	3
43	F005431	Socket Head Cap Screw	M10x40	3
44	S90-1000-44G	Top Hook Holder		1
45	S90-1000-45	Top Idle Shaft		1
46	S90-1000-46	Roller Pin	4x40mm	25
47	S90-1000-47	Top Idle Sheave		1
48	S90-1000-48G	Lock Nut and Lock Washer	M10	3
49	S90-1000-49G	Bottom Hook Assembly		1
		Bottom Hook		1
		Hook Collar Bushing		1
		Roller	10mm	13
51	S90-1000-51	Hook Shaft		1
52	S90-1000-52	Hook Shaft Snap Ring	ø32 mm	2
53	S90-1000-53	Idle Shaft Snap Ring	ø25 mm	4
	L100-WT	Warning Tag (not shown)		1

Note: When ordering replacement chains (index #6 and 28), specify length.

13.0 Warranty and Service

JET® warrants every product it sells against manufacturers' defects. If one of our tools needs service or repair, please contact Technical Service by calling 1-800-274-6846, 8AM to 5PM CST, Monday through Friday.

Warranty Period

The general warranty lasts for the time period specified in the literature included with your product or on the official JET branded website.

- JET products carry a limited warranty which varies in duration based upon the product. (See chart below)
- Accessories carry a limited warranty of one year from the date of receipt.
- Consumable items are defined as expendable parts or accessories expected to become inoperable within a reasonable amount of use and are covered by a 90 day limited warranty against manufacturer's defects.

Who is Covered

This warranty covers only the initial purchaser of the product from the date of delivery.

What is Covered

This warranty covers any defects in workmanship or materials subject to the limitations stated below. This warranty does not cover failures due directly or indirectly to misuse, abuse, negligence or accidents, normal wear-and-tear, improper repair, alterations or lack of maintenance. JET woodworking machinery is designed to be used with Wood. Use of these machines in the processing of metal, plastics, or other materials outside recommended guidelines may void the warranty. The exceptions are acrylics and other natural items that are made specifically for wood turning.

Warranty Limitations

Woodworking products with a Five Year Warranty that are used for commercial or industrial purposes default to a Two Year Warranty. Please contact Technical Service at 1-800-274-6846 for further clarification.

How to Get Technical Support

Please contact Technical Service by calling 1-800-274-6846. **Please note that you will be asked to provide proof of initial purchase when calling.** If a product requires further inspection, the Technical Service representative will explain and assist with any additional action needed. JET has Authorized Service Centers located throughout the United States. For the name of an Authorized Service Center in your area call 1-800-274-6846 or use the Service Center Locator on the JET website.

More Information

JET is constantly adding new products. For complete, up-to-date product information, check with your local distributor or visit the JET website.

How State Law Applies

This warranty gives you specific legal rights, subject to applicable state law.

Limitations on This Warranty

JET LIMITS ALL IMPLIED WARRANTIES TO THE PERIOD OF THE LIMITED WARRANTY FOR EACH PRODUCT. EXCEPT AS STATED HEREIN, ANY IMPLIED WARRANTIES OF MERCHANTABILITY AND FITNESS FOR A PARTICULAR PURPOSE ARE EXCLUDED. SOME STATES DO NOT ALLOW LIMITATIONS ON HOW LONG AN IMPLIED WARRANTY LASTS, SO THE ABOVE LIMITATION MAY NOT APPLY TO YOU.

JET SHALL IN NO EVENT BE LIABLE FOR DEATH, INJURIES TO PERSONS OR PROPERTY, OR FOR INCIDENTAL, CONTINGENT, SPECIAL, OR CONSEQUENTIAL DAMAGES ARISING FROM THE USE OF OUR PRODUCTS. SOME STATES DO NOT ALLOW THE EXCLUSION OR LIMITATION OF INCIDENTAL OR CONSEQUENTIAL DAMAGES, SO THE ABOVE LIMITATION OR EXCLUSION MAY NOT APPLY TO YOU.

JET sells through distributors only. The specifications listed in JET printed materials and on official JET website are given as general information and are not binding. JET reserves the right to effect at any time, without prior notice, those alterations to parts, fittings, and accessory equipment which they may deem necessary for any reason whatsoever. JET® branded products are not sold in Canada by JPW Industries, Inc.

Product Listing with Warranty Period

90 Days – Parts; Consumable items
1 Year – Motors; Machine Accessories
2 Year – Metalworking Machinery; Electric Hoists, Electric Hoist Accessories
5 Year – Woodworking Machinery
Limited Lifetime – JET Parallel clamps; VOLT Series Electric Hoists; Manual Hoists; Manual Hoist Accessories; Shop Tools; Warehouse & Dock products; Hand Tools; Air Tools

NOTE: JET is a division of JPW Industries, Inc. References in this document to JET also apply to JPW Industries, Inc., or any of its successors in interest to the JET brand.

This page intentionally left blank.



427 New Sanford Road
LaVergne, Tennessee 37086
Phone: 800-274-6848
www.jettools.com